

 **STRIDER**<sup>®</sup>  
14x Sport

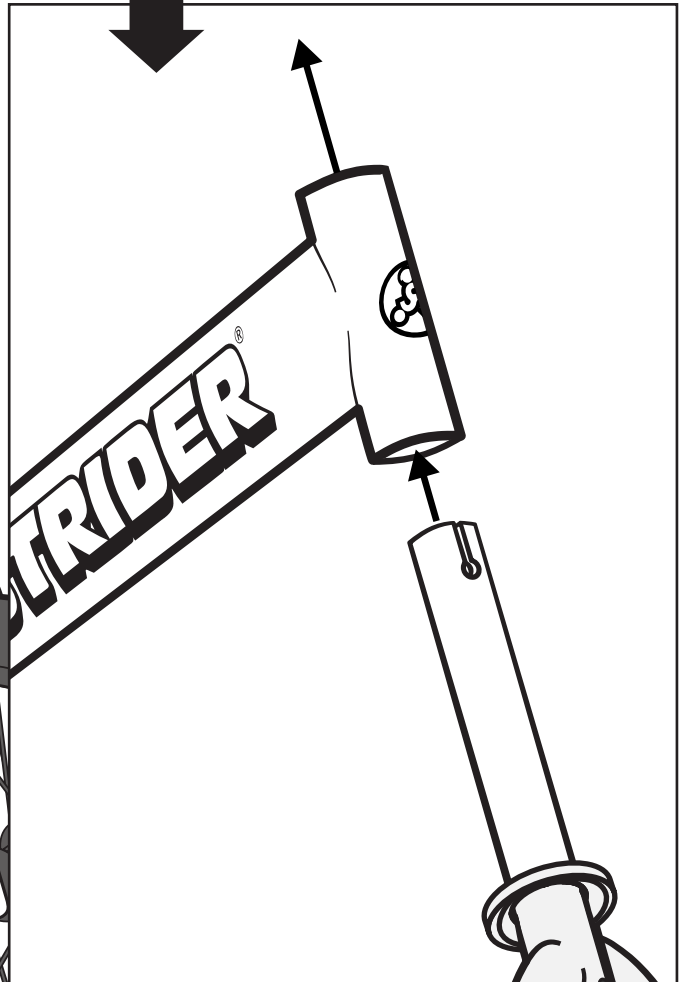

[striderbikes.com/assembly](http://striderbikes.com/assembly)

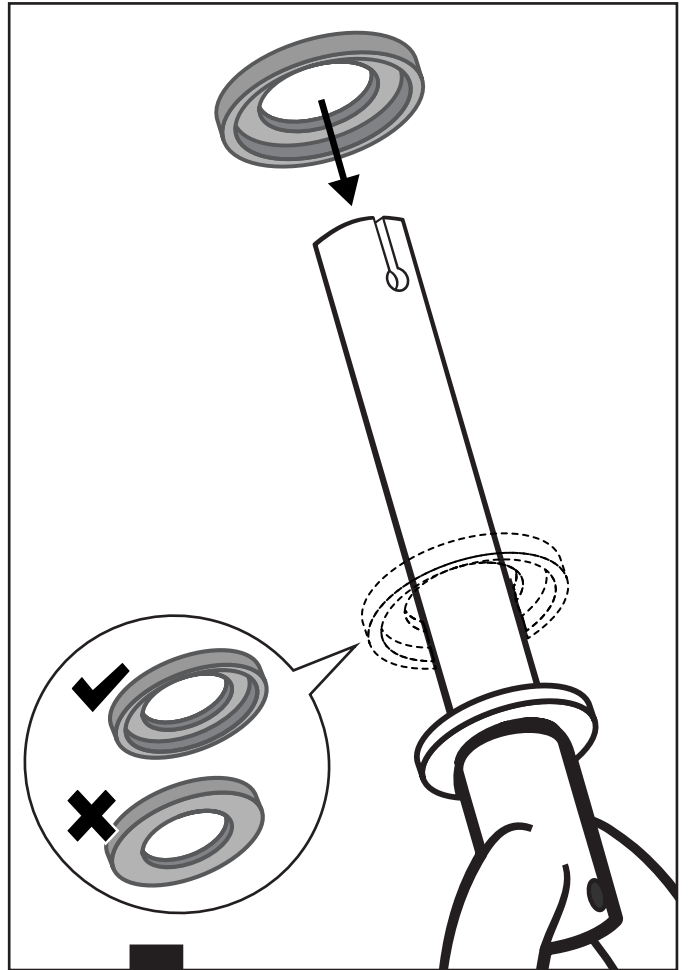

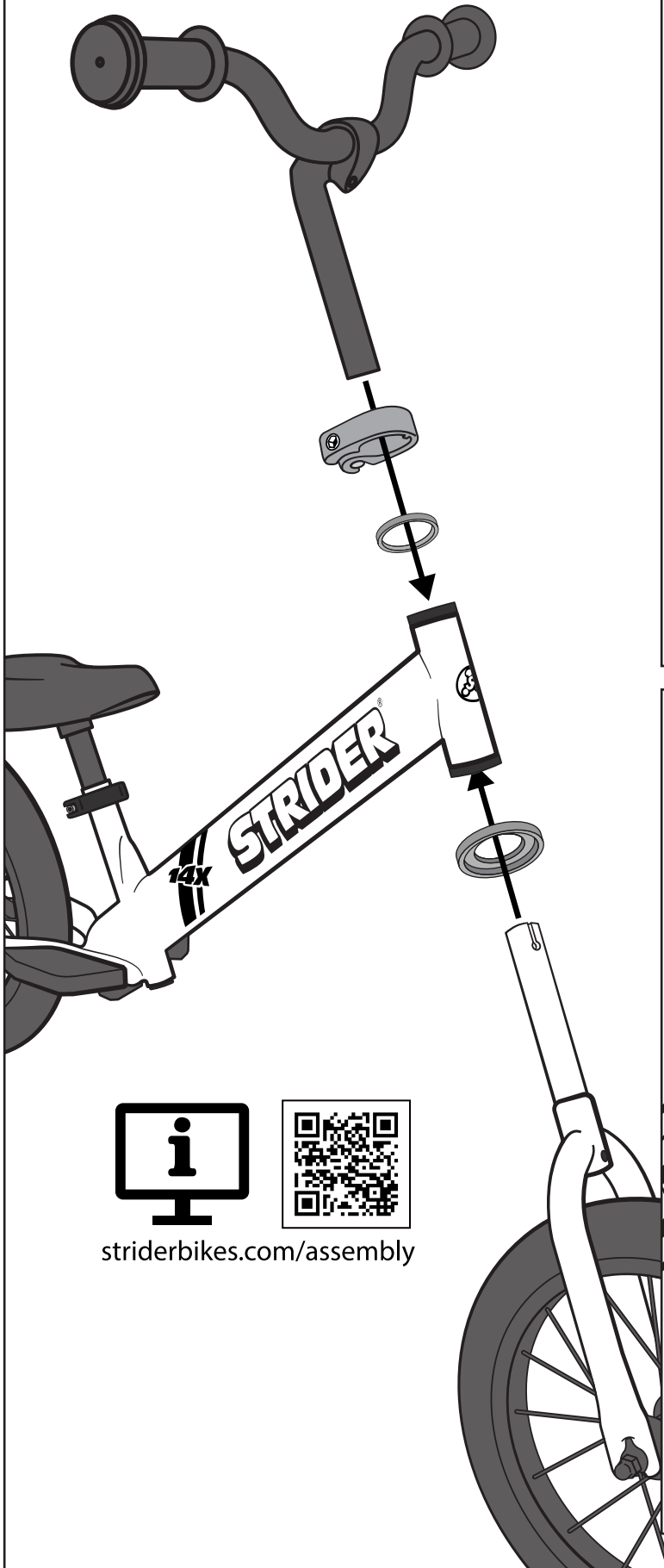
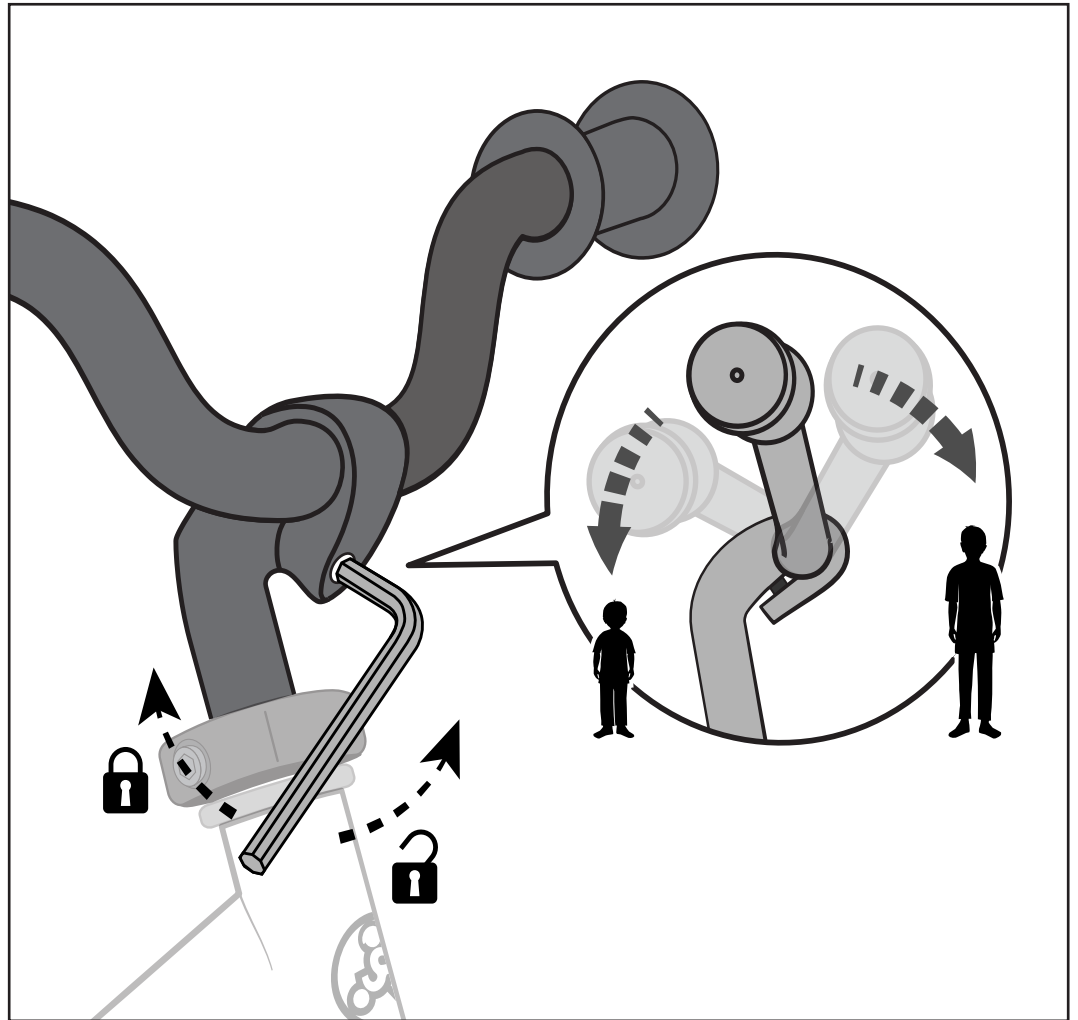
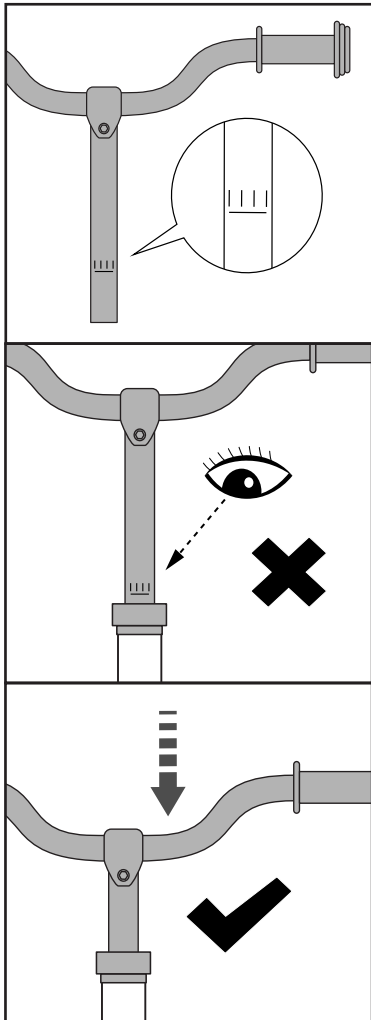
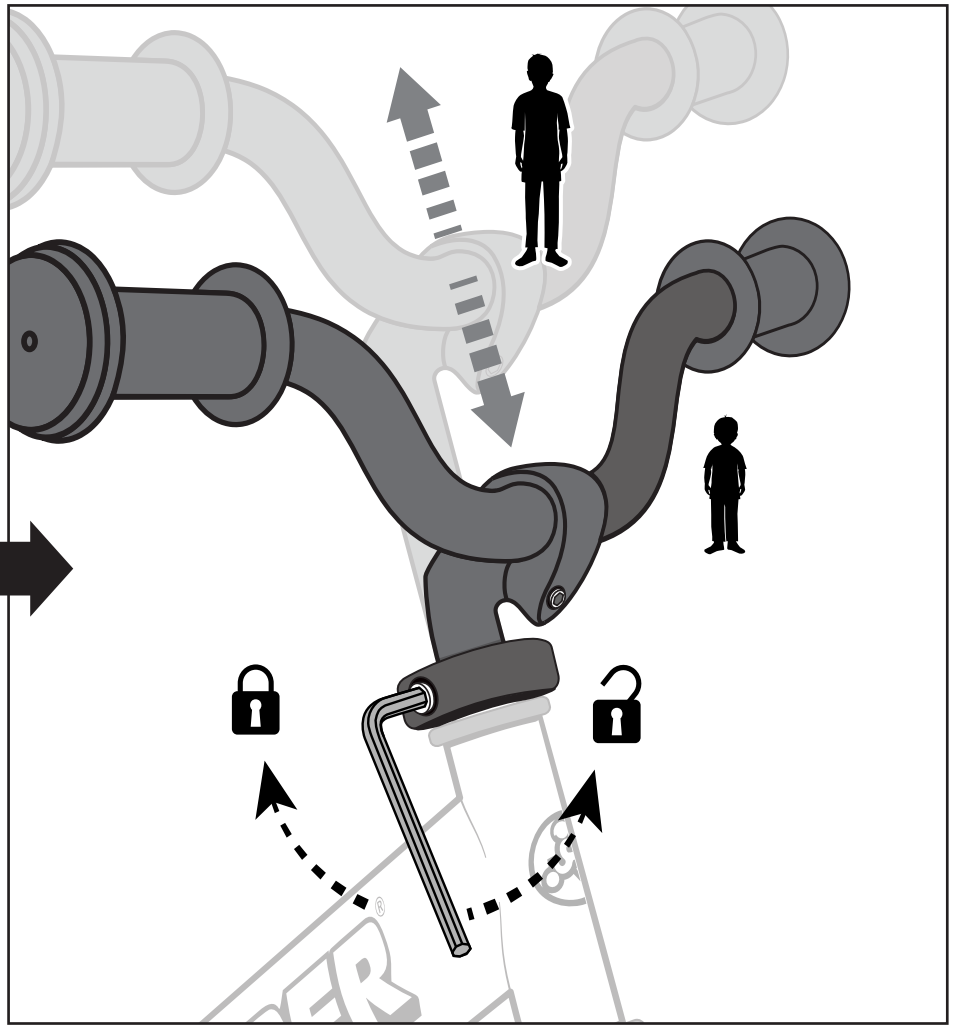
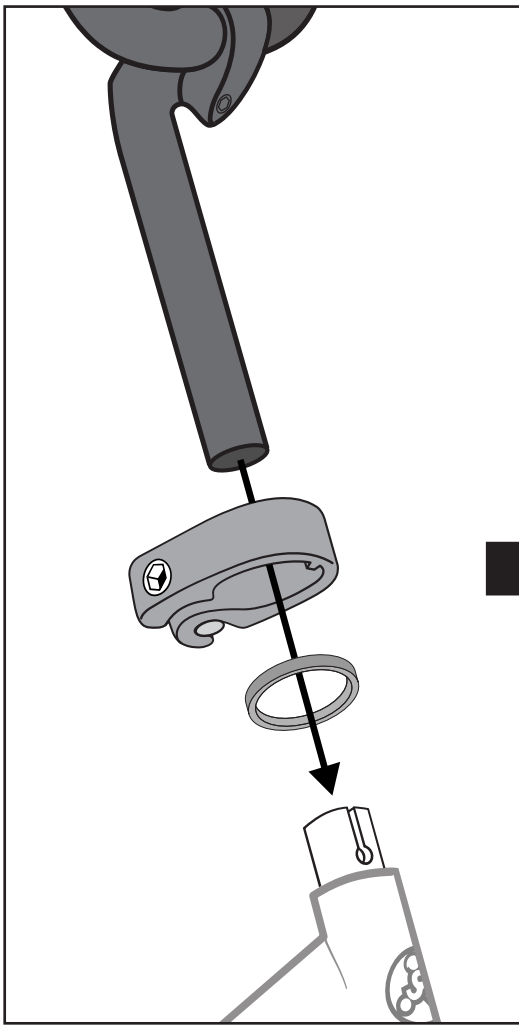
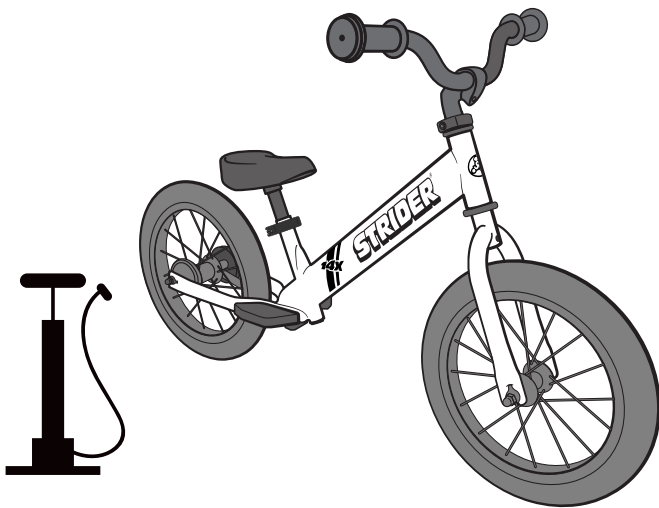
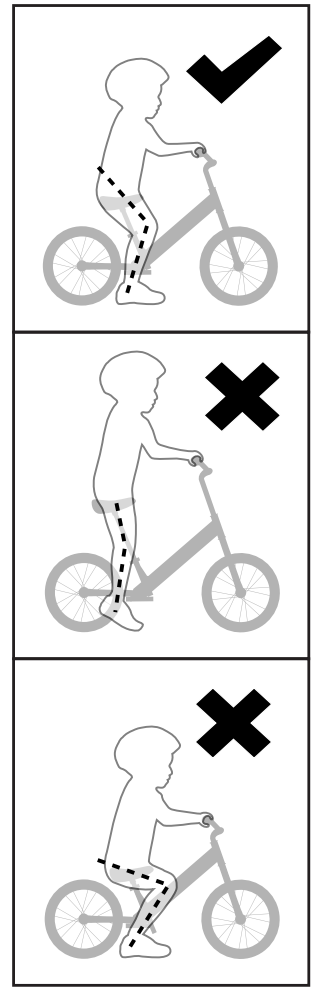
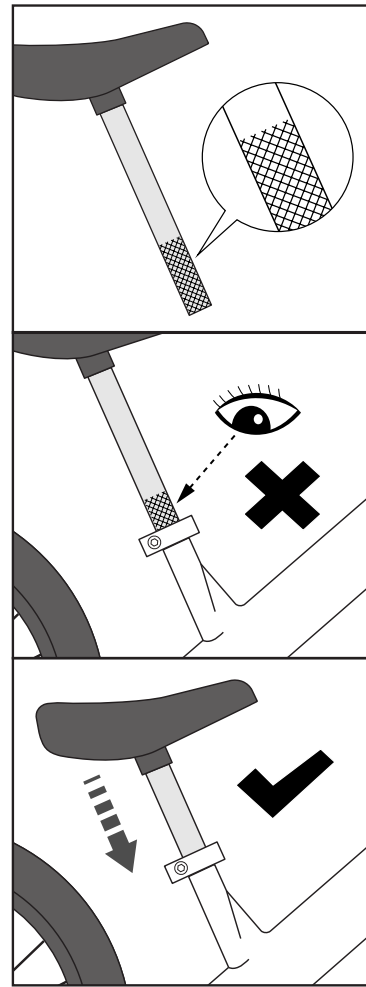
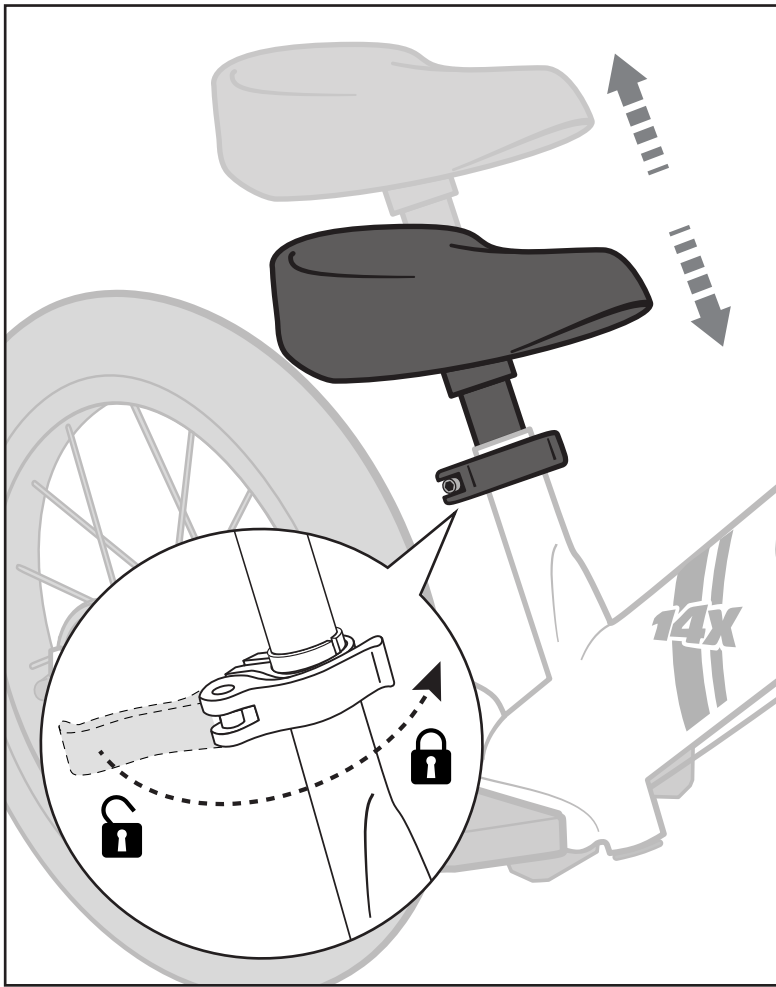

**@StriderBikes**  
     
**www.StriderBikes.com**



**WARNING: TO AVOID SERIOUS INJURY:** Adult supervision is always required; always use in safe areas; always wear sturdy shoes and a properly adjusted helmet. Un-assembled bike and container have parts that are a **CHOKING HAZARD** to young children. Regularly inspect the bike and replace worn components as necessary. 60-Day Satisfaction Guarantee, 2-Year Warranty against manufacturing defects. To activate your warranty, or before returning your bike, please visit [www.StriderBikes.com/Warranty-Registration](http://www.StriderBikes.com/Warranty-Registration). This product is subject to various registered United States and International intellectual property interests including patents, trademarks and/or copyrights. Details of these interests may be found at [www.StriderBikes.com/IP](http://www.StriderBikes.com/IP)  
 ©2019 Strider Sports Int'l Inc. 2221 N Plaza Drive, Rapid City, SD. U.S.A. 57702 All rights reserved. Manufactured and printed in China. Please retain this guide for future reference. 10869-C [US]

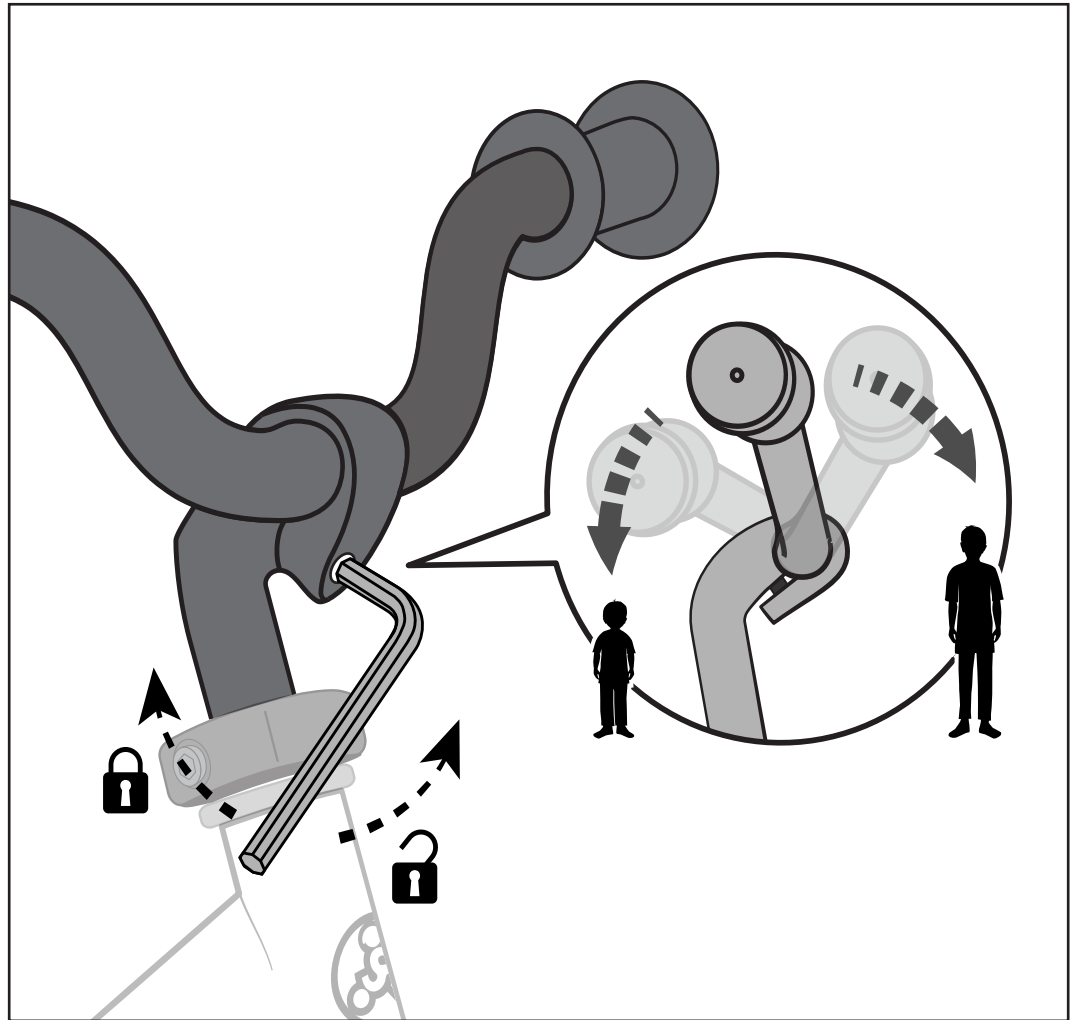
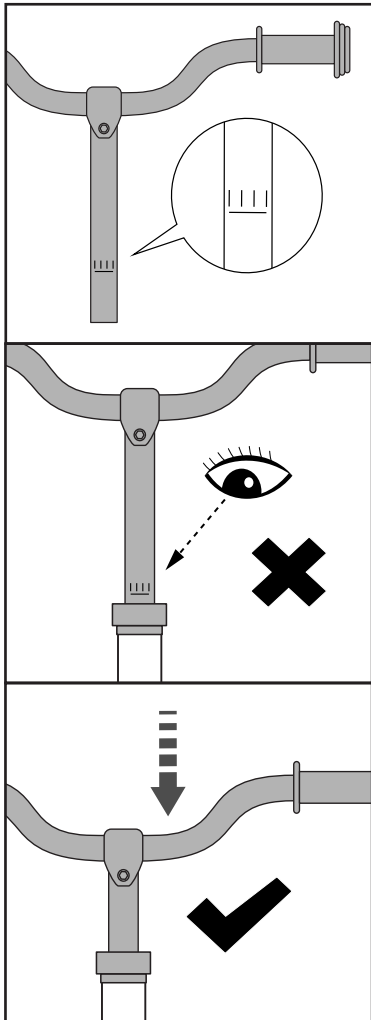
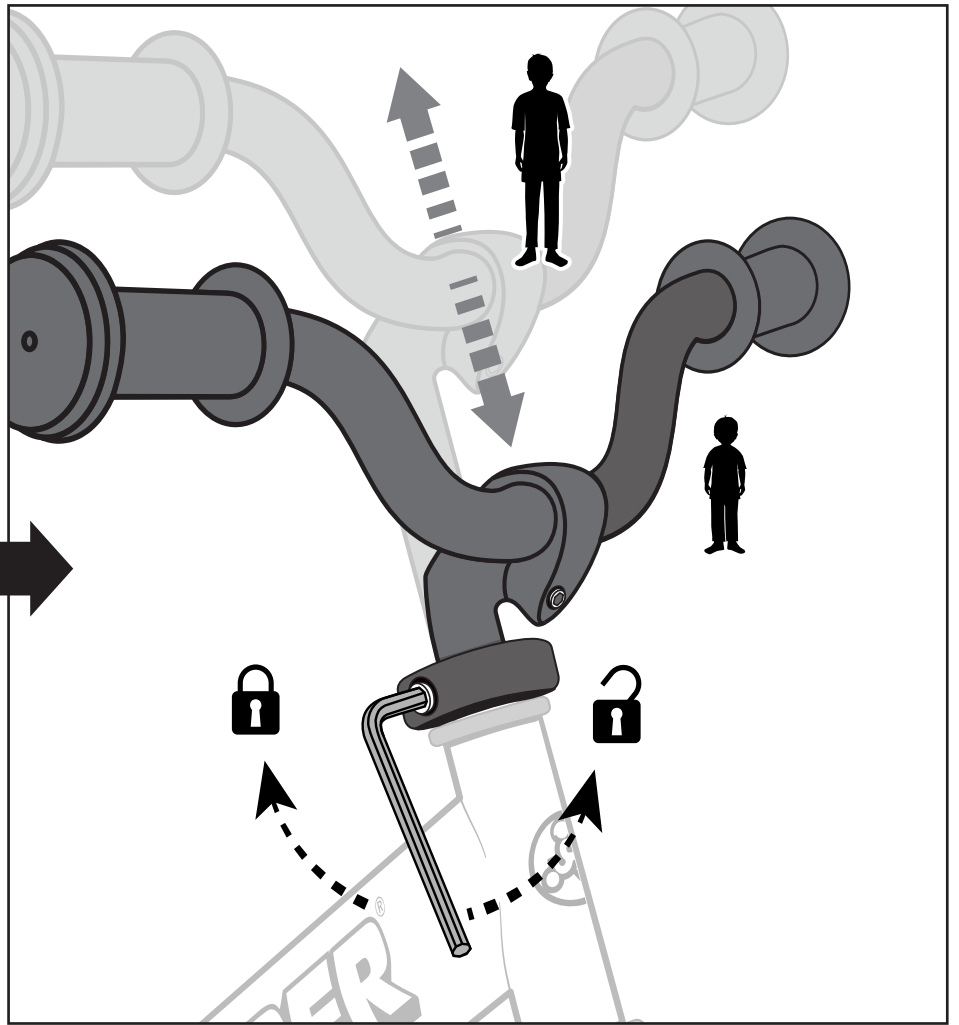
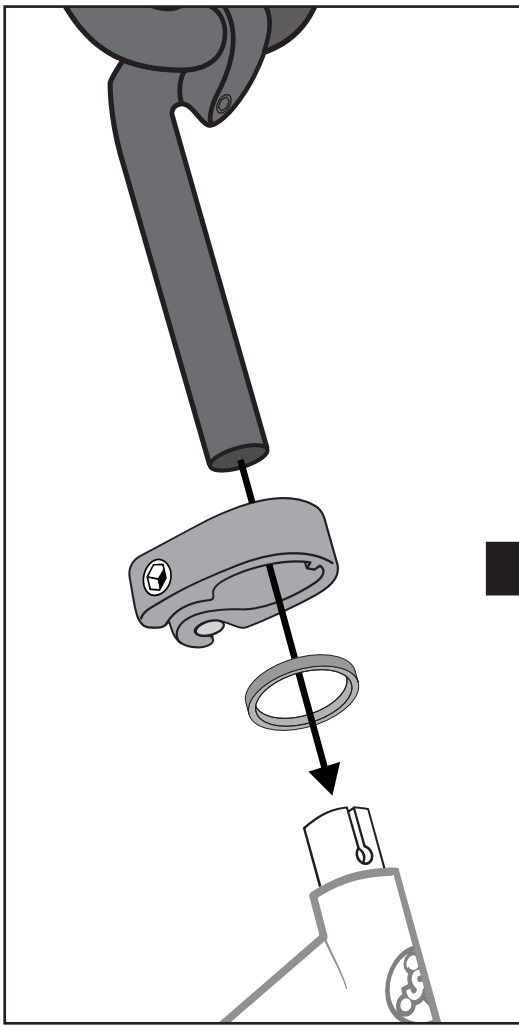

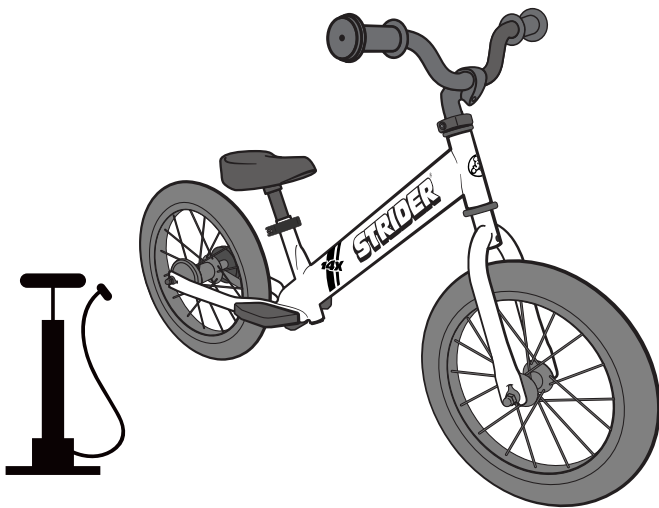
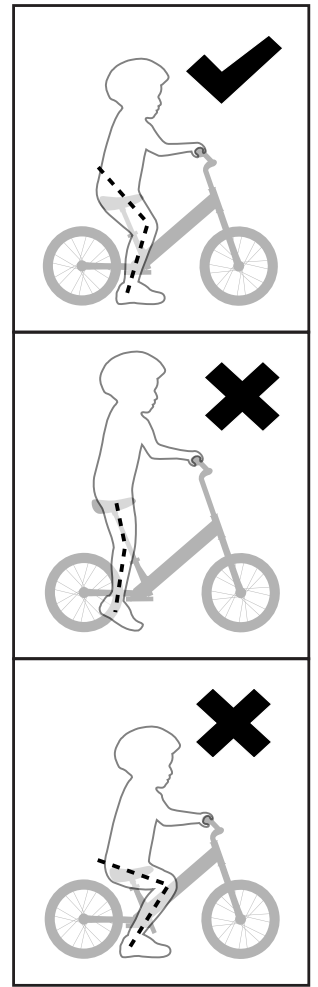
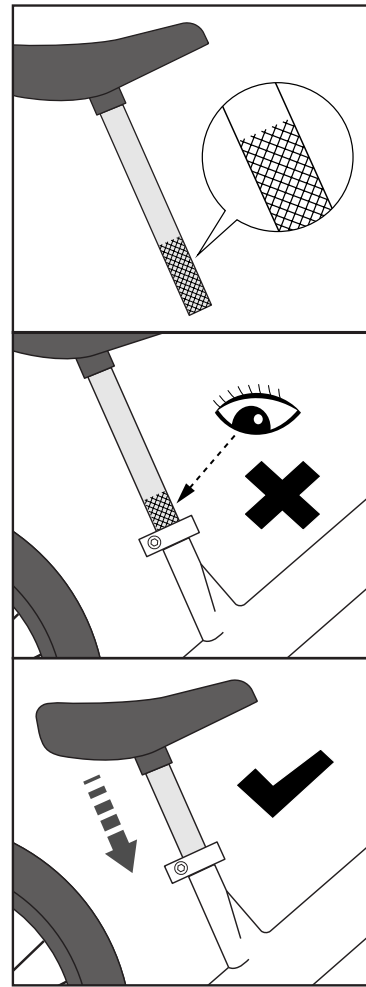
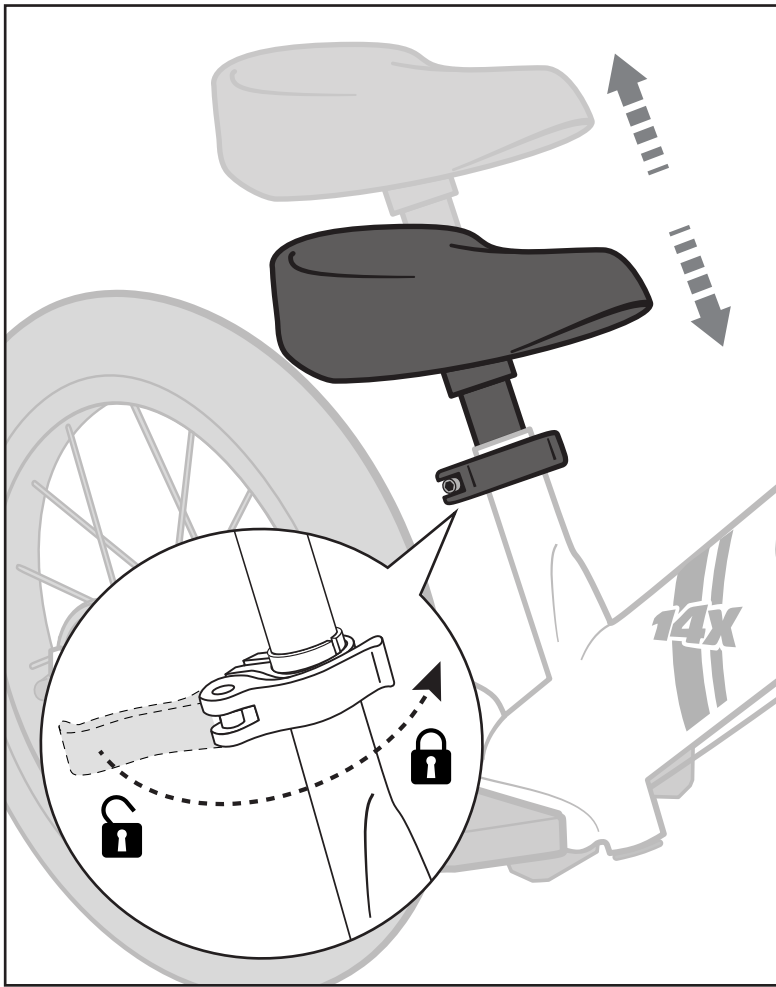

**@StriderBikes**  
     
**www.StriderBikes.com**



**WARNING: TO AVOID SERIOUS INJURY:** Adult supervision is always required; always use in safe areas; always wear sturdy shoes and a properly adjusted helmet. Un-assembled bike and container have parts that are a **CHOKING HAZARD** to young children. Regularly inspect the bike and replace worn components as necessary. 60-Day Satisfaction Guarantee, 2-Year Warranty against manufacturing defects. To activate your warranty, or before returning your bike, please visit [www.StriderBikes.com/Warranty-Registration](http://www.StriderBikes.com/Warranty-Registration). This product is subject to various registered United States and International intellectual property interests including patents, trademarks and/or copyrights. Details of these interests may be found at [www.StriderBikes.com/IP](http://www.StriderBikes.com/IP)  
 ©2019 Strider Sports Int'l Inc. 2221 N Plaza Drive, Rapid City, SD. U.S.A. 57702 All rights reserved. Manufactured and printed in China. Please retain this guide for future reference. 10869-C [US]